

# Sabina II

## Quick Reference Guide

English

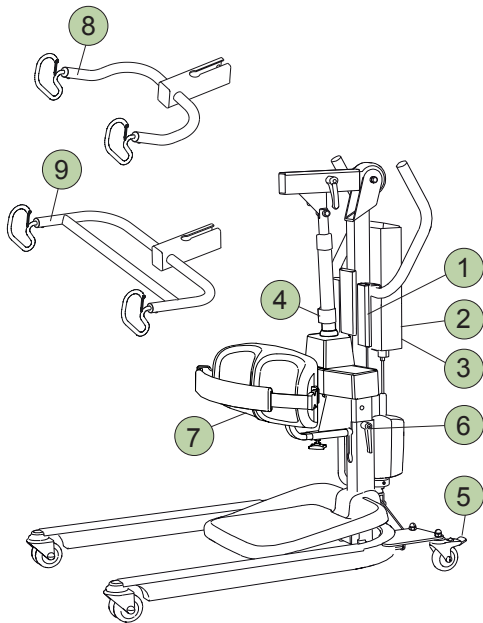

### Safety Instructions

- Read the instruction guides for the lift and lifting accessories before use.
  - Plan the lifting operation carefully.
  - Check to ensure that the sling's strap loops are correctly connected to the sling bar hooks when the sling strap is extended, but before the patient is lifted from the underlying surface.
  - **Maximum load active lifting: 200 kg (440 lbs)**  
**Maximum load passive lifting: 150 kg (330 lbs)**
- To retain max. load it is essential to use accessories rated for the same max. load or greater.

### IMPORTANT!

This quick reference guide does not replace the lift's instruction guide, which can be downloaded at [www.liko.com](http://www.liko.com).

### 1 Hand Control

Sabina II EE Sabina II EM

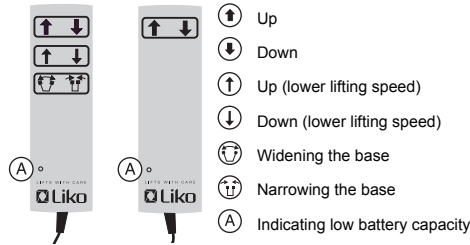

### 2 Emergency Stop

Activate:

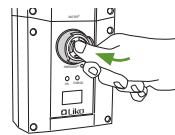

Reset:

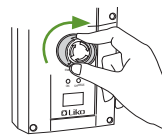

### 3 Electrical Emergency Lowering / Raising

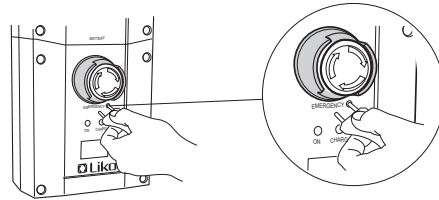

⚠ The object used to press must not be sharp, since this may cause damage on the control box!

### 4 Mechanical Emergency Lowering

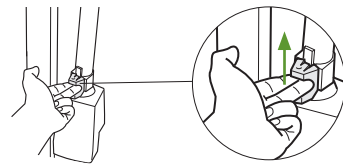

### 5 Locking the Wheels

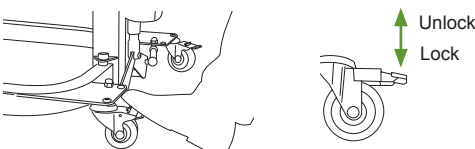

### Adjustments

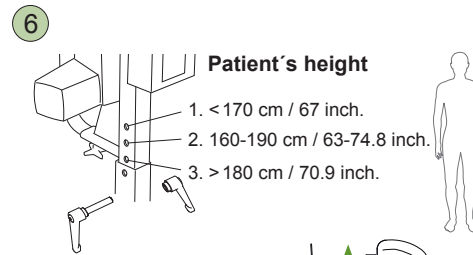

### 7 Lower-leg support

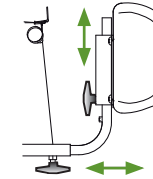

### Alternative Use

#### 8 SlingBar 350

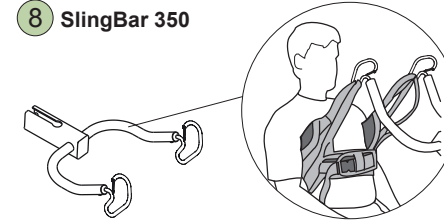

#### 9 Comfort SlingBar

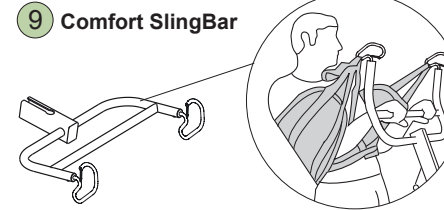

### Charging the Batteries



Charge immediately!



Fully charged

- Charge the lift regularly after use.
- The lift does not function during charging.
- **The emergency stop should not be pressed in during charging.**

### Ergonomics

- Never lift manually – let the lift do the lifting.
- Take it easy. Work calmly and methodically.
- Don't strain your back! Work in a walking stance with your back straight.
- Reduce the lever effect. Work close to the patient and the lift.

### Cleaning

When necessary, clean the lift with a moist cloth, using common surface cleaners or disinfectants.

### Simple Troubleshooting

**Check to ensure that:**

- the emergency stop is not pressed in, see 2
- the battery is charged
- the hand control is properly connected.

### Other Quick Reference Guides

Quick reference guides for Liko's lifts and slings are available for downloading at [www.liko.com](http://www.liko.com).

© Copyright Liko AB



A Hill-Rom Company

[www.liko.com](http://www.liko.com)

Manufacturer:

Liko AB  
Nedre vägen 100  
SE-975 92 Luleå  
Sweden  
info@liko.se